

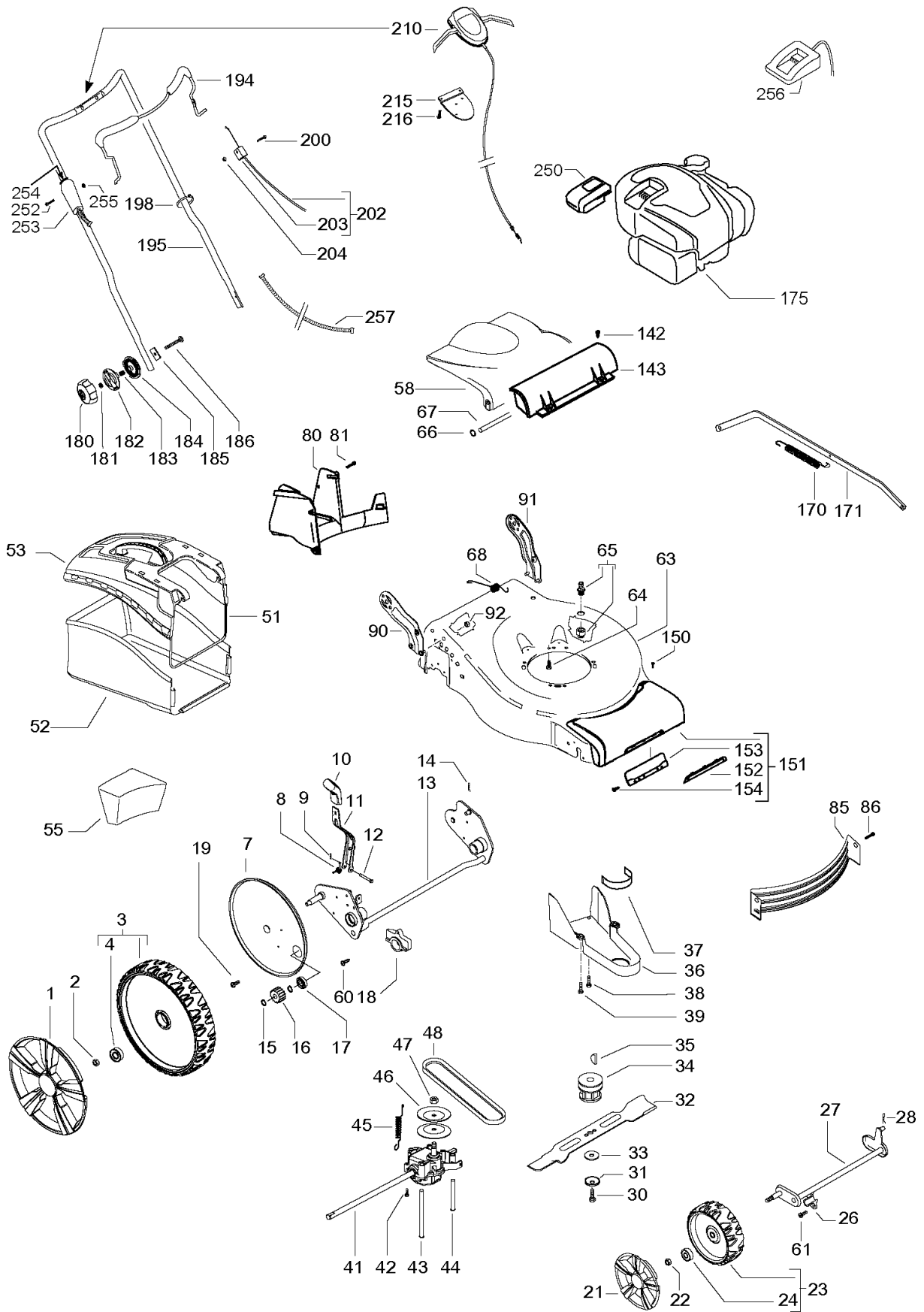

SPARE PARTS LIST

LAWN MOWERS: CONSUMER
WALK-BEHINDS

M46-160 AWREX, 96762180100, 2017-01



PRODUCT COMPLETE

M46-160 AWREX, 96762180100, 2017-01

Ref	Part No	Description	Remark	QTY	KIT
1	574 39 66-01	HUB CAP	d.280	2	
2	504 85 78-01	NUT	M8, self locking, flanged	2	
3	574 45 12-02	WHEEL ASSY	d.280	2	
4	531 20 87-78	BEARING		4	3
7	504 53 99-01	HUB CAP	d.280	2	
8	583 95 13-02	SPRING		1	
9	531 20 74-08	PIN RETAINING SCREW		1	
10	580 46 24-01	KNOB		1	
11	582 75 93-01	LEVER ASSY		1	
12	587 19 82-01	PEN		1	
13	510 09 28-01	REAR AXLE		1	
14	531 20 66-53	PIN		1	
15	531 20 87-72	WASHER		4	
16	544 34 23-01	PINION		2	
17	531 20 87-78	BEARING		2	
18	531 20 59-44	SUPPORT		2	
19	531 20 78-56	SCREW	M5x10	4	
21	574 39 64-01	HUB CAP	d.190	2	
22	504 85 78-01	NUT	M8, self locking, flanged	2	
23	574 45 09-02	WHEEL ASSY	d.190	2	
24	531 20 87-78	BEARING		4	23
26	577 38 42-01	SUPPORT		2	
27	504 85 65-01	FRONT AXLE ASSY		1	
28	531 20 66-53	PIN		1	
30	531 20 80-08	SCREW	3/8"	1	
31	531 20 72-37	WASHER		1	
32	580 25 92-02	MOWER BLADE		1	
33	531 20 72-43	WASHER		1	
34	504 59 12-01	BLADE SUPPORT		1	
35	504 59 14-01	KEY		1	
36	589023101	TBD		1	
37	501 18 90-02	BELT GUIDE		1	
38	817 41 13-12	SCREW		1	
39	531 20 78-56	SCREW	5x10	2	
41	504 54 14-02	GEARBOX		1	
42	510 03 75-01	SCREW	4x16, self threading	2	
43	544 93 44-01	BELT GUIDE		1	
44	544 93 43-01	BELT GUIDE		1	
45	544 93 47-01	SPRING		1	
46	504 54 79-01	PULLEY		2	
47	504 54 80-01	NUT		1	
48	504 03 48-01	BELT	Z28 10X710	1	
51	574 86 94-01	FRAME		1	
52	574 86 96-02	GRASSBAG		1	
53	574 61 03-01	GRASSBAG		1	
55	579 67 92-01	PLUG		1	
58	574 61 02-01	HATCH		1	
60	531 20 66-77	SCREW	4.8x19, self threading	2	
61	525 43 31-01	SCREW	4x16, self threading	4	
63	501 30 48-02	CHASSIS		1	
64	532 15 04-06	BOLT	3/8"	3	
65	531 20 58-48	CONNECTOR	1/2"	1	
66	584 81 69-03	LOCKWASHER		2	
67	531 21 14-41	TIE ROD		1	
68	531 21 18-40	SPRING		1	
80	589023001	TBD		1	
81	532 14 24-32	SCREW		5	
85	589008701	TBD		1	
86	817 00 05-10	BOLT		2	
90	582 75 06-02	HANDLE BRACKET	right	1	
91	582 75 02-02	HANDLE BRACKET	left	1	
92	582 75 89-01	HEXAGON NUT FLANGE	M8	4	
142	576 13 60-06	SCREW	M5x8	2	
143	579 30 09-01	SEAL		1	

PRODUCT COMPLETE

M46-160 AWREX, 96762180100, 2017-01

Ref	Part No	Description	Remark	QTY	KIT
150	576 04 74-01	SCREW CRPANT	M5x16	2	
151	575 56 21-04	FRONT COVER ASSY		1	
152	574 37 52-01	COVER		1	151
153	574 72 17-01	ATTACHMENT PLATE		1	151
154	575 95 57-01	SCREW ITXPANT		2	151
170	579 24 53-02	SPRING		1	
171	580 96 33-01	ROD		1	
175	N/A	TBD	engine, Briggs & Stratton, model number 104M0B0078H1	1	
180	580 42 43-01	KNOB		2	
181	531 20 49-22	WASHER		2	
182	531 21 14-74	SEGMENT	outer	2	
183	531 21 14-76	SPRING		2	
184	531 21 14-73	SEGMENT	inner	2	
185	531 21 15-81	PLATE		2	
186	581 25 95-01	SCREW RSQM	M8x55	2	
194	587 68 93-03	BAIL ARM ASSY		1	
195	580 33 36-02	HANDLE		1	
198	531 20 55-81	CLIP		4	
200	580 83 36-01	SCREW EHHM		1	
202	582 19 21-01	CABLE ASSY		1	
203	531 20 80-43	BRACKET		1	202
204	581 55 12-01	HEXAGON LOCKING NUT		1	
210	580 68 39-01	CONTROL		1	
215	587 24 93-02	BACKPLATE		1	
216	532 18 16-98	SCREW		4	
250	501741702	TBD		1	
252	544 21 84-40	SCREW ITXSCM		1	
253	587 93 43-01	STARTER ASSY		1	
254	580 91 52-03	BUTTON		1	
255	732 21 16-01	NUT		1	
256	501741802	TBD		1	
257	501 27 09-02	WIRING ASSY		1	