

THS Li-18/42 Art. 8881

- D Betriebsanleitung**
Accu-Teleskop-Heckenschere
- GB Operating Instructions**
Telescopic Accu Hedge Trimmer
- F Mode d'emploi**
Taille-haies télescopique sur accu
- NL Gebruiksaanwijzing**
Telescopische accu-heggenschaar
- S Bruksanvisning**
Accu Teleskophäckssax
- DK Brugsanvisning**
Akku-teleskop-hækkeklipper
- FI Käyttöohje**
Teleskooppivarrellinen akkupensasleikkuri
- N Bruksanvisning**
Batteri-teleskop-hekksaks
- I Istruzioni per l'uso**
Tagliasiepi telescopica a batteria
- E Instrucciones de empleo**
Recortasetos telescópico con Accu
- P Manual de instruções**
Corta-sebes telescópico accu
- PL Instrukcja obsługi**
Akumulatorowe nożyce do żywopłotu z trzonkiem teleskopowym
- H Használati utasítás**
Akkumulátoros-teleszkópos sövénynyíró
- CZ Návod k obsluze**
Akumulátorové teleskopické nůžky na živý plot
- SK Návod na obsluhu**
Akumulátorové nožnice na živý plot
- GR Οδηγίες χρήσης**
Τηλεσκοπικό μπουρντουροψάλιδο μπαταρίας
- RUS Инструкция по эксплуатации**
Аккумуляторные телескопические ножницы для живых изгородей
- SLO Navodilo za uporabo**
Akumulatorske teleskopske škarje za živo mejo
- HR Upute za uporabu**
Teleskopske škare za živicu s akumulatorom
- SRB Uputstvo za rad**
BIH Teleskopske baterijske makaze za živicu
- UA Інструкція з експлуатації**
Акумуляторний телескопічний садовий секатор
- RO Instrucțiuni de utilizare**
Trimmer telescopic cu acumulator pentru gard viu
- TR Kullanma Kılavuzu**
Akkülü teleskopik çit budayıcı
- BG Инструкция за експлоатация**
Аккумуляторна телескопична ножица за жив плет
- AL Manual përdorimi**
Gërshërë gardhesh teleskopike me bateri
- EST Kasutusjuhend**
Aku ja teleskoopvarrega hekikäärid
- LT Eksploatavimo instrukcija**
Akumuliatorinės teleskopinės gyvatvorių žirkklės
- LV Lietošanas instrukcija**
Teleskopiskās dzīvžogu šķēres ar akumulatoru

GARDENA Telescopic Accu Hedge Trimmer THS Li-18/42



Translation of the original German operating instructions.

Please read the operating instructions carefully and observe the notes given. Use these operating instructions to familiarise yourself with the product, the proper use and the safety instructions.



For safety reasons, children and young people under the age of 16, as well as people not familiar with these operating instructions, may not use this product. Persons with reduced physical or mental abilities may use the product only if they are supervised or instructed by a responsible person. Children must be supervised to ensure that they do not play with the product.

→ Keep these operating instructions in a safe place.

Contents:

1. Area of application of your GARDENA Telescopic Accu Hedge Trimmer	13
2. Safety Instructions	13
3. Assembly	16
4. Initial Operation	16
5. Operation	18
6. Storage	19
7. Maintenance	20
8. Troubleshooting	20
9. Available accessories	21
10. Technical Data	21
11. Service/Warranty	22

1. Area of application of your GARDENA Telescopic Accu Hedge Trimmer

Correct Use:

This GARDENA Telescopic Accu Hedge Trimmer is intended for the cutting of hedges, shrubs and grass coverings in private domestic gardens and allotments.

Adherence to these operating instructions is a precondition for the correct use of the hedge trimmer.

Please note:



WARNING! Risk of injury!

The hedge trimmer must not be used for cutting lawns/lawn edges or for chopping up material for composting purposes.

2. Safety Instructions



If not used properly this product can be dangerous. The warnings and safety instructions must be followed to ensure reasonable safety and efficiency in using this product. The operator is responsible for following the warnings and instructions in this manual and on the product. Never use the product unless the guards provided by the manufacturer are in the correct position.

Explanation of Symbols on your product.



WARNING!

Read the user instructions carefully to make sure you understand all the controls and what they do.



Risk of fatal injury due to electric shock!

Keep at least 10 m away from electricity lines.



Always wear eye and ear protection.



Do not expose to rain.

Do not leave the product outdoors while it is raining.

General Power Tool Safety Warnings



WARNING ! Read all safety warnings and all instructions.

Failure to follow the warnings and instructions may result in electric shock, fire and / or serious injury.

Save all warnings and instructions for future reference.

The term "power tool" in the warnings refers to your mains operated (corded) power tool or battery-operated (cordless) power tool.

1) Work area safety

a) Keep work area clean and well lit.

Cluttered or dark areas invite accidents.

b) Do not operate power tools in explosive atmospheres, such as in the presence of flammable liquids, gases or dust.

Power tools create sparks which may ignite the dust or fumes.

c) Keep children and bystanders away while operating a power tool. Distractions can cause you to lose control.

2) Electrical safety

a) Power tool plugs must match the outlet. Never modify the plug in any way. Do not use any adaptor plugs with earthed (grounded) power tools.

Unmodified plugs and matching outlets will reduce risk of electric shock.

b) Avoid body contact with earthed or grounded surfaces, such as pipes, radiators, ranges and refrigerators. There is an increased risk of electric shock if your body is earthed or grounded.

c) Do not expose power tools to rain or wet conditions. Water entering a power tool will increase the risk electric shock.

d) Do not abuse the cord. Never use the cord for carrying, pulling or unplugging the power tool. Keep cord away from heat, oil, sharp edges or moving parts. Damaged or entangled cords increase the risk of electric shock.

e) When operating a power tool outdoors, use an extension cord suitable for outdoor use. Use of a cord suitable for outdoor use reduces the risk of electric shock.

f) If operating a power tool in a damp location is unavoidable, use a residual current device (RCD) protected supply.

Use of an RCD reduces the risk of electric shock.

3) Personal safety

a) Stay alert, watch what you are doing and use common sense when operating a power tool. Do not use a power tool while you are tired or under the influence of drugs, alcohol or medication.

A moment of inattention while operating power tools may result in serious personal injury.

b) Use personal protective equipment. Always wear eye protection.

Protective equipment such as dust mask, non-skid safety shoes, hard hat, or hearing protection used for appropriate conditions will reduce personal injuries.

c) Prevent unintentional starting. Ensure the switch is in the off-position before connecting to power source and / or battery pack, picking up or carrying the tool.

Carrying power tools with your finger on the switch or energising power tools that have the switch on invites accidents.

d) Remove any adjusting key or wrench before turning the power tool on.

A wrench or a key left attached to a rotating part of the power tools may result in personal injury.

e) Do not overreach. Keep proper footing and balance at all times. This enables better control of the power tool in unexpected situations.

f) Dress properly. Do not wear loose clothing or jewellery. Keep your hair, clothing and gloves away from moving parts. Loose clothes, jewellery or long hair can be caught in moving parts.

g) If devices are provided for the connection of dust extraction and collection facilities, ensure these are connected and properly used.

Use of dust collection can reduce dust-related hazards.

4) Power tool use and care

a) Do not force the power tool. Use the correct power tool for your application.

The correct power tool will do the job better and safer at the rate for which it was designed.

b) Do not use the power tool if the switch does not turn it on and off.

Any power tool that cannot be controlled with the switch is dangerous and must be repaired.

c) Disconnect the plug from the power source and / or the battery pack from the power tool before making any adjustments, changing accessories, or storing power tools. Such preventive safety measures reduce the risk of starting the power tool accidentally.

d) Store idle power tools out of the reach of children and do not allow persons unfamiliar with the power tool or these instructions to operate the power tool.

Power tools are dangerous in the hands of untrained users.

e) Maintain power tools.

Check for misalignment or binding of moving parts, breakage of parts and any other condition that may affect the power tool's operation. If damaged, have the power tool repaired before use.

Many accidents are caused by poorly maintained power tools.

f) Keep cutting tools sharp and clean.

Properly maintained cutting tools with sharp cutting edges are less likely to bind and are easier to control.

g) Use the power tool, accessories and tool bits etc. in accordance with these instructions, taking into account the working conditions and the work to be performed.

Use of the power tool for operations different from those intended could result in a hazardous situation.

5) Battery tool use and care

a) Recharge only with the charger specified by the manufacturer.

A charger that is suitable for one type of battery pack may create a risk of fire when used with another battery pack.

b) Use power tools only with specifically designated battery packs.

Use of any other battery packs may create a risk of injury and fire.

c) When battery pack is not in use, keep it away from other metal objects, like paper clips, coins, keys, nails, screws or other small metal objects, that can make a connection from one terminal to another.

Shorting the battery terminals together may cause burns or a fire.

d) Under abusive conditions, liquid may be ejected from the battery; avoid contact. If contact accidentally occurs, flush with water. If liquid contacts eyes, additionally seek medical help.

Liquid ejected from the battery may cause irritation or burns.

6) Service

a) Have your power tool serviced by a qualified repair person using only identical replacement parts.

This will ensure that the safety of the power tool is maintained.

Hedge trimmer safety warnings:

- **Keep all parts of the body away from the cutter blade. Do not remove cut material or hold material to be cut when blades are moving. Make sure the switch is off when clearing jammed material.**

A moment of inattention while operating the hedge trimmer may result in serious personal injury.

- **Carry the hedge trimmer by the handle with the cutter blade stopped. When transporting or storing the hedge trimmer always fit the cutting device cover.**

Proper handling of the hedge trimmer will reduce possible personal injury from the cutter blades.

- **Hold the power tool by insulated gripping surfaces only, because the cutter blade may contact hidden wiring.**

Cutter blades contacting a "live" wire may make exposed metal parts of the power tool "live" and could give the operator an electric shock.

Additional Safety Recommendations

Work area safety

Only use the product in the manner and for the functions described in these instructions.

The operator or user is responsible for accidents or hazards occurring to other people or their property. Pay special attention to the hazard for third parties posed by the increased working radius when the telescopic tube is extended.

Warning! When wearing hearing protection, and due to the noise produced by the unit, the operator may not notice persons approaching.

Warning! This unit makes an electromagnetic field while it operates. This field may under some conditions interfere with active or passive medical implants.

To decrease the risk of conditions that can possibly injure or kill, we recommend persons with medical implants to speak with their physician and the medical implant manufacturer before operating.

Do not use the product when a thunderstorm is approaching.

Warning! Keep toddlers away when you assemble the unit. Small parts can be easily swallowed. There is also a risk that the polybag can suffocate toddlers.

Electrical safety

Only connect charger to the AC voltage specified on the rating plate.

Under no circumstances should an earth be connected to any part of the product.

Personal safety

Always wear suitable clothing, gloves, and stout shoes.

Avoid contact to the oil of the blade in particular when you react allergic with it.

Thoroughly inspect the area where the product is to be used and remove all wires and other foreign objects.

All adjustments (inclining the blade head, altering the length of the telescopic tube) have to be made with the sheath in place, and the Hedge Trimmer must not rest on the blade in the process.

Before using the machine and after any impact, check for signs of wear or damage and repair as necessary.

Never attempt to use an incomplete product or one with an unauthorised modification.

Power tool use and care

Know how to stop the product quickly in an emergency. Never hold the product by the guard.

Do not use the Hedge Trimmer if the protection equipment are damaged.

Do not use ladders whilst operating the product.

Remove the battery:

- before leaving the product unattended for any period;
- before clearing a blockage;

- before checking, cleaning or working on the appliance;
- if you hit an object. Do not use your product until you are sure that the entire product is in a safe operating condition;
- if the product starts to vibrate abnormally. Check immediately. Excessive vibration can cause injury.
- before passing to another person.

Maintenance and storage



RISK OF INJURY!

Do not touch blades.

→ When work is finished or interrupted, refit the protective blade cover.

All nuts and screws must be firmly tightened to ensure a safe operating condition of the device.

If the unit got hot during operation, let it cool down before storage.

Battery safety



FIRE RISK!

The battery to be charged must be placed on a non-flammable, heat resistant and non-conductive surface while charging. Keep corrosive, flammable and easily combustible objects clear of the battery charger and the battery. Do not cover the battery charger and the battery while charging. Unplug the battery charger immediately in the event of smoke formation or fire.

Only use the GARDENA Battery Charger supplied.

The use of other battery chargers may damage the batteries irreparably and even cause a fire.



RISK OF EXPLOSION!

→ Protect battery from heat and fire. Do not leave on radiators or expose to strong sunshine for long periods.



Do not use the battery charger outdoors.

→ Protect the the battery charger from damp or wet areas.

Only use the battery in ambient temperatures of between 0 °C and 40 °C.

A non-functioning battery must be disposed of correctly. It may not be sent via post. For further details, please contact your local disposal companies.

The charging cable should be checked regularly for signs of damage or ageing (brittleness) and may only be used if it is in perfect condition.

The charger unit provided may only be used to charge the rechargeable batteries supplied with the Hedge Trimmer.

Non-rechargeable batteries must not be charged with this battery charger (danger of fire).

After charging, disconnect the charger from the mains and from the battery.

Only charge battery between 0 – 45 °C. After heavy duty service allow battery to cool down first.

Storage

The Hedge trimmer must not be stored over 35 °C or under direct exposure to sunlight.

Do not store the Hedge Trimmer in places with static electricity.

3. Assembly

Installing the telescopic handle:

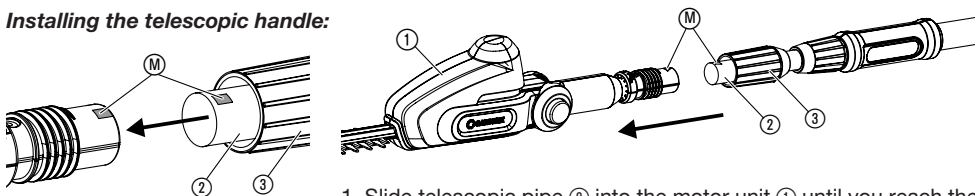

1. Slide telescopic pipe ② into the motor unit ① until you reach the stop position. Ensure that the two markings **M** face each other.
2. Tighten the grey nut ③.

4. Initial Operation

Charging the battery:



WARNING!

Overvoltage damages batteries and the battery charger.

→ Ensure the correct mains voltage.

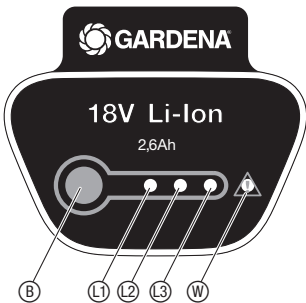
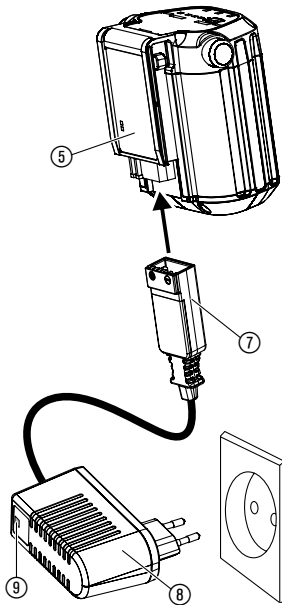
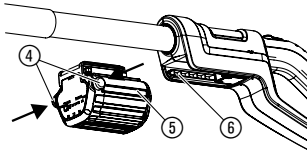

Before using for the first time, the battery must be fully charged. Charging time (for uncharged battery) see 10. Technical Data.

The lithium-ion battery can be charged in any state of charge, and the charging process can be interrupted at any time without harming the battery (no memory effect).

1. Depress both locking buttons (4) and remove the battery (5) from the battery holder (6) on the handle.
2. Plug the plug of the charger cable (7) into the battery (5).
3. Plug battery charger (8) into a mains socket.

Charging indicator lamp (9) at the charger unit flashes green once per second: Battery is being charged.

Charging indicator lamp (9) at the charger unit is lit green: Battery is fully charged.

(For charging time, see 10. Technical Data.)

Battery charging status indicator during charging:

100 % charged	L1, L2 and L3 lit.
66 – 99 % charged	L1 and L2 lit, L3 flashing.
33 – 65 % charged	L1 lit, L2 flashing.
0 – 32 % charged	L1 flashing.

Check the charge status regularly while charging.

4. Once completely charged, disconnect the battery (5) from the battery charger (8). Disconnect the battery (5) from the battery charger (8) first, then unplug the battery charger (8).
5. Slide battery (5) onto the battery holder (6) on the handle until it audibly engages.

Avoid exhaustive discharge:

If the battery is empty, the full discharge protection automatically switches off the device to prevent the battery from discharging fully. To prevent the fully charged battery from self-discharging via the unplugged charger, it should be disconnected from the charger after charging. If the battery was stored for more than 1 year, it must be fully recharged.

If the battery was fully discharged, the charging indicator lamp (9) will flash rapidly at the start of charging (twice per second).

If the charging indicator lamp (9) still flashes rapidly after 10 minutes, a fault has occurred (see 8. Troubleshooting).

If the error-LED (W) on the battery flashes, a fault has occurred (see 8. Troubleshooting). In case of a completely empty battery it will take approx. 20 minutes until the LEDs on the battery will indicate charging. But the charging process is indicated by the flashing LED (9) on the charger.

Battery charging status indicator during operation:

→ Press button (B) on the battery.

66 – 99 % charged	L1, L2 and L3 lit.
33 – 65 % charged	L1 and L2 lit.
10 – 32 % charged	L1 lit.
1 – 9 % charged	L1 flashing.
0 % charged	No indicator.

5. Operation

Working positions:

The hedge trimmer can be operated in 4 working positions (illustration similar).

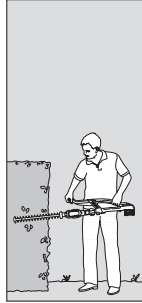

Side trimming:
Telescopic pipe retracted

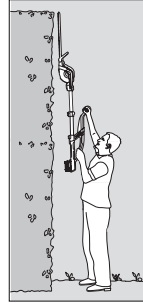

Vertical trimming at high level:
Telescopic tube extended

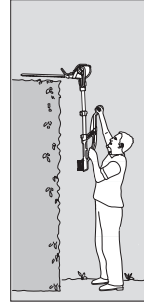

Horizontal trimming at high level:
Motor unit tilted by 75°, telescopic pipe extended

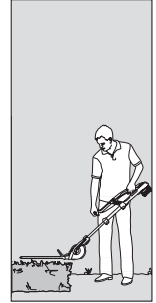

Trimming at low level:
Motor unit tilted by -60°, telescopic pipe extended

Tilting the motor unit:

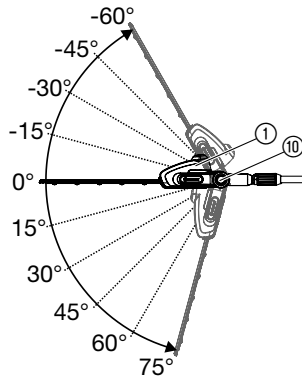

Extending the telescopic pipe:

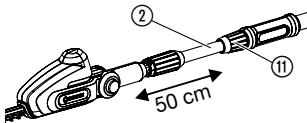

For trimming at high and low level, the motor unit ① can be tilted at an angle of 75° to -60° in 15° increments.

1. Remove the battery from the handle (see 4. Initial Operation).
2. Keep both orange buttons ⑩ pressed.
3. Tilt motor unit ① in the required direction.
4. Release both orange buttons ⑩ and allow motor unit ① to engage.
5. Put the battery on the handle (see 4. Initial Operation).

For cutting at high and low heights, the telescopic pipe ② can be continuously extended by up to 50 cm.

1. Remove the battery from the handle (see 4. Initial Operation).
2. Loosen the orange nut ⑪, extend the telescopic pipe ② to the required length, and tighten the orange nut ⑪ again.
3. Put the battery on the handle (see 4. Initial Operation).

Starting the Hedge Trimmer:

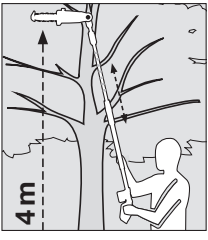
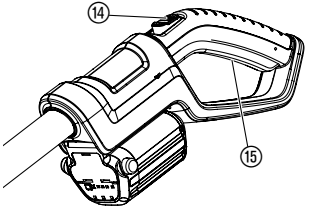
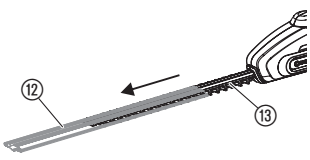

⚠ DANGER! Risk of physical injury!
If the Hedge Trimmer does not switch off automatically, there is a risk of lacerations.
→ Never override the safety devices (e.g. by strapping down the starting lock-out or the start button).

Switching on the Hedge Trimmer:

1. Remove the protective cover (12) from blade (13).
2. Put the battery on the handle (see 4. Initial Operation).
3. Hold the telescopic pipe of the Hedge Trimmer with one hand and the handle with the other hand.
4. Push the starting lock-out (14) forwards and press the start button (15). *The Hedge Trimmer will start.*
5. Release the starting lock-out (14).

Switching the Hedge Trimmer off :

1. Release the start button (15).
2. Remove the battery from the handle (see 4. Initial Operation).
3. Slide the protective cover (12) over the cutter blade (13).

6. Storage

To put into storage:

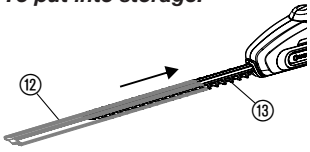

Store out of the reach of children.

1. Remove and charge battery (see 4. Initial Operation).
2. Clean the hedge trimmer (see 7. Maintenance) and slide the protective cover (12) over the cutter blade (13).
3. Store the hedge trimmer in a dry, frost free place.

Disposal:
(in accordance with
RL 2012/19/EU)



The unit must not be added to usual household waste. Refer to local environmental laws for discarding.

→ Important: Make sure that the unit is disposed of via your municipal recycling collection centre.

Disposal of batteries:



The GARDENA battery contains lithium-ion cells that should not be discarded with normal household waste at the end of their life.

Important:
Please return the lithium-ion batteries to your GARDENA dealer or dispose of them properly at a public recycling centre.

1. Discharge lithium-ion batteries completely.
2. Dispose of lithium-ion batteries properly.

7. Maintenance

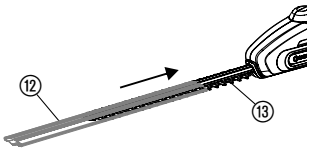

⚠ DANGER! Risk of physical injury!
 Cutting injuries can be caused if the hedge trimmer does switch on unintentionally.
 → Before maintenance, remove the battery (see 4. Initial Operation) and slide the protective cover (12) over the cutter blade (13).

Cleaning the Hedge Trimmer:

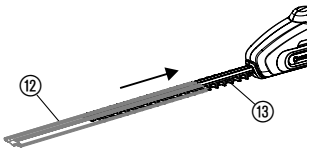

⚠ ATTENTION ! Damage to the hedge trimmer!
 → Never clean the hedge trimmer under running water or with a water jet (in particular a high pressure water jet).





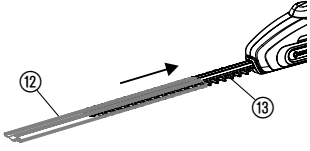

1. Clean the hedge trimmer with a damp cloth.
2. Clean the airflow slots with a soft brush (do not use a screwdriver).
3. Clean the blade (13) with a brush, if required, and lubricate with a low-viscosity oil (e.g. GARDENA Spray Oil Art. 2366). Avoid contact of the oil with the plastic parts and wear gloves.

8. Troubleshooting



⚠ DANGER! Risk of physical injury!
 Cutting injuries can be caused if the hedge trimmer does switch on unintentionally.
 → Remove the battery before troubleshooting (see 4. Initial Operation) and slide the protective cover (12) over the cutter blade (13).

Problem	Possible Cause	Remedy
Hedge trimmer does not start	Battery is flat.	→ Charge battery (see 4. Initial Operation).
	Battery not pushed onto the handle properly.	→ Push battery onto the handle and make sure that the locking buttons snaps in correctly.
	Blade soiled (e.g. by resin).	→ Clean blade (see 7. Maintenance).
	Blade blocked.	→ Remove obstacle.
Hedge is not cleanly cut	Blade blunt or damaged.	→ Have blade replaced by GARDENA-Service.
The Hedge Trimmer can no longer be switched off	Start button is stuck.	→ Remove battery and loosen start button.
Hedge Trimmer stops. Error-LED (W) flashes	Battery overload.	→ Wait for 10 sec. Press button (E) on the battery and restart.

Problem	Possible Cause	Remedy
Hedge Trimmer stops. Error-LED  flashes	High temperature. The allowed operation temperature was exceeded.	→ Leave battery to cool for approx. 15 min. Press button  on the battery and restart.
Charging indicator lamp  on the charger does not light up	Battery charger or charging cable not plugged in properly.	→ Plug in battery charger and charging cable properly.
Charging control lamp  on the charger flashes rapidly (twice per second)	Charging error.	→ Unplug charger and plug in again.
Hedge Trimmer stops. Error-LED  flashes.	Battery error/ battery defective.	→ Press button  on the battery and restart.
The battery can no longer be charged	Battery is defective.	→ Replace the battery (Art. 9840).

Only an original GARDENA BLi-18 Replaceable Battery (Art. 9840) may be used.
This can be obtained from your GARDENA dealer or directly from GARDENA Service.



**For any other malfunctions please contact the GARDENA service department.
Repairs must only be done by GARDENA service departments or specialist dealers approved by GARDENA.**

9. Available accessories

GARDENA Replacement Battery BLi-18	Battery for additional duration or for replacement.	Art. 9840
GARDENA Maintenance Oil	Increases the service life of the blade and battery life.	Art. 2366

10. Technical Data

THS Li-18/42 (Art. 8881)	
Strokes	2100/min.
Length of cutter blade	42 cm
Tooth gap of cutter blade	16 mm
Range of extension of telescopic tube	0 – 50 cm
Weight including battery	3.4 kg
Workplace related sound pressure level $L_{PA}^{1)}$ Uncertainty K_{PA}	70 dB(A) 3 dB(A)
Noise emission value $L_{WA}^{2)}$ Uncertainty K_{WA}	measured 87 dB(A) / guaranteed 90 dB(A) 3 dB(A)
Hand/arm vibration $a_{vhw}^{1)}$ Uncertainty K_a	< 2.5 m/s ² 1.5 m/s ²

Battery	lithium ion (18 V)
Battery capacity	2.6 Ah
Battery charging time	approx. 3.5 h 80 % / approx. 5 h 100 %
Idling time*	approx. 90 min. (with full battery)
Battery charger	
Mains voltage	230 V / 50 – 60 Hz
Max. output current	600 mA
Output voltage	18 V (DC)

Measuring process complying with ¹⁾ EN 60745-2-15 ²⁾ RL2000/14/EC.

* The actual running time may differ from the stated idle time depending on application, type of cuttings and state of maintenance.



The stated vibration emission value has been measured according to a standardised test procedure and can be used for comparison of one electric power tool with another. It can also be used for preliminary evaluation of exposure. The vibration emission value can vary during actual use of the electric power tool.

11. Service/Warranty

Service:

Please contact the address on the back page.

Guarantee:

GARDENA Manufacturing GmbH guarantees this unit for 2 years (from date of purchase). This guarantee covers all serious defects of the unit that can be proved to be material or manufacturing faults. Under warranty we will either replace the unit or repair it free of charge if the following conditions apply:

- The unit must have been handled properly and in keeping with the requirements of the operating instructions.
- Neither the purchaser or a non-authorised third party have attempted to repair the unit.

The blade and eccentric drive are wearing parts and are not covered by the guarantee.

This manufacturer's guarantee does not affect the user's existing warranty claims against the dealer/seller.

If you have problems with this unit, please contact our Service.

D Produkthaftung

Wir weisen ausdrücklich darauf hin, dass wir nach dem Produkthaftungsgesetz nicht für durch unsere Geräte hervorgerufene Schäden einzustehen haben, sofern diese durch unsachgemäße Reparatur verursacht oder bei einem Teileaustausch nicht unsere originale GARDENA Teile oder von uns freigegebene Teile verwendet wurden und die Reparatur nicht vom GARDENA Service oder dem autorisierten Fachmann durchgeführt wird. Entsprechendes gilt für Ergänzungssteile und Zubehör.

GB Product Liability

We expressly point out that, in accordance with the product liability law, we are not liable for any damage caused by our units if it is due to improper repair or if parts exchanged are not original GARDENA parts or parts approved by us, and, if the repairs were not carried out by a GARDENA Service Centre or an authorised specialist. The same applies to spare parts and accessories.

F Responsabilité

Nous vous signalons expressément que GARDENA n'est pas responsable des dommages causés par ses appareils, dans la mesure où ces dommages seraient causés suite à une réparation non conforme, dans la mesure où, lors d'un échange de pièces, les pièces d'origine GARDENA n'auraient pas été utilisées, ou si la réparation n'a pas été effectuée par le Service Après-Vente GARDENA ou l'un des Centres SAV agréés GARDENA. Ceci est également valable pour tout ajout de pièces et d'accessoires autres que ceux préconisés par GARDENA.

NL Productaansprakelijkheid

Wij wijzen er nadrukkelijk op, dat wij op grond van de wet aansprakelijkheid voor producten niet aansprakelijk zijn voor schade ontstaan door onze apparaten, indien deze door onvakkundige reparatie veroorzaakt zijn, of er bij het uitwisselen van onderdelen geen gebruik gemaakt werd van onze originele GARDENA onderdelen of door ons vrijgegeven onderdelen en de reparatie niet door de GARDENA technische dienst of de bevoegde vakman uitgevoerd werd. Ditzelfde geldt voor extra-onderdelen en accessoires.

S Produktansvar

Tillverkaren är inte ansvarig för skada som orsakats av produkten om skadan beror på att produkten har reparerats felaktigt eller om, vid reparation eller utbyte, andra än Original GARDENA reservdelar har använts. Samma sak gäller för kompletteringsdelar och tillbehör.

DK Produktansvar

Vi gør udtrykkeligt opmærksom på, at vi i henhold til produktansvarsloven ikke er ansvarlige for skader forårsaget af vores udstyr, såfremt det sker på grund af uautoriserede reparationer eller hvis dele er skiftet ud og der ikke er anvendt originale GARDENA dele eller dele godkendt af os, eller hvis reparationerne ikke er udført af GARDENA-service eller en autoriseret fagmand. Det samme gælder for ekstra udstyr og tilbehør.

FI Tuotevastuu

Korostamme nimenomaan, että tuotevastuulain nojalla emme ole vastuussa laitteistamme johtuneista vahingoista, mikäli nämä ovat aiheutuneet epäasianmukaisesta korjauksesta tai osia vaihdettaessa ei ole käytetty alkuperäisiä GARDENA-varaosia tai hyväksymiämme osia ja korjauksen on suorittanut muu kuin GARDENA-huoltokeskus tai valtuuttamamme ammattihenkilö. Tämä pätee myös lisäksiin ja lisävarusteisiin.

I Responsabilità del prodotto

Si rende espressamente noto che, conformemente alla legislazione sulla responsabilità del prodotto, non si risponde di danni causati da nostri articoli se originati da riparazioni eseguite non correttamente o da sostituzioni di parti effettuate con materiale non originale GARDENA o comunque da noi non approvato e, in ogni caso, qualora l'intervento non venga eseguito da un centro assistenza GARDENA o da personale specializzato autorizzato. Lo stesso vale per le parti complementari e gli accessori.

E Responsabilidad de productos

Advertimos que conforme a la ley de responsabilidad de productos no nos responsabilizamos de daños causados por nuestros aparatos, siempre y cuando dichos daños hayan sido originados por arreglos o reparaciones indebidas, por recambios con piezas que no sean piezas originales GARDENA o bien piezas no autorizadas por nosotros, así como en aquellos casos en que la reparación no haya sido efectuada por un Servicio Técnico GARDENA o por un técnico autorizado. Lo mismo es aplicable para las piezas complementarias y accesorios.

P Responsabilidade sobre o produto

Queremos salientar que segundo a lei da responsabilidade do fabricante, nós não nos responsabilizaremos por danos causados pelo nosso equipamento, quando estes ocorrerem em decorrência de reparações inadequadas ou da substituição de peças por peças não originais da GARDENA, ou peças não autorizadas.

A responsabilidade tornar-se-à nula também depois de reparações realizadas por oficinas não autorizadas pela GARDENA. Esta restrição valerá também para peças adicionais e acessórios.

PL Odpowiedzialność za produkt

Zwracamy Państwu uwagę, że nie ponosimy odpowiedzialności za uszkodzenia naszych maszyn, bądź szkody spowodowane ich wadliwym funkcjonowaniem, powstałe na skutek nieprawidłowo przeprowadzonych napraw lub użycia nieoryginalnych części zamiennych. Naprawy winny być przeprowadzane tylko przez punkty serwisowe Husqvarna lub autoryzowane serwisy. Dotyczy to również części uzupełniających i oprzyrządowania.

H Termékszavatosság

Nyomatékosan utalunk arra a tényre, hogy a termékszavatossági törvény szerint nem kell jótállást vállalnunk azokra a károokra, amelyeket nem a mi készülékeink okoztak, ha ezeket átkészületlen javítás okozta vagy egy alkatrész kicserélésénél nem a mi eredeti GARDENA alkatrészeinket vagy általunk engedélyezett alkatrészeket használtak fel és a javítást nem a GARDENA szerviz vagy egy erre felhatalmazott szakember végezte. Hasonlóképpen érvényes ez a kiegészítő alkatrészekre és tartozékokra is.

CZ Odpovědnost za výrobek

Výslovně upozorňujeme na to, že podle zákona o odpovědnosti za výrobek neneseme odpovědnost za škody způsobené našimi přístroji, pokud byly způsobené neodbornou opravou nebo použitím jiných než našich originálních náhradních dílů GARDENA nebo námi schválených dílů a neprovedením opravy servisem GARDENA nebo autorizovaným odborníkem. Odpovídající platí i pro doplňkové díly a příslušenství.

SK Predmet záruky

Upozorňujeme dôrazne na to, že podľa zákona o poskytovaní záruk nezodpovedáme za škody spôsobené našimi výrobkami, v prípade, že boli boli vyvolané neodbornými opravami, výmenou dielcov, ktoré nepatria k originálnym dielom GARDENA alebo neboli nami schválené a rovnako boli spôsobené servisnými zásahmi, ktoré neboli vykonané servisom GARDENA alebo autorizovaným odborníkom. Rovnako to platí pre doplnky a príslušenstvo.

GR Ευθύνη για το προϊόν

Σας υπενθυμίζουμε ρητά, ότι σύμφωνα με το νόμο περί ευθύνης για τα προϊόντα δεν ευθυνόμαστε για ενδεχόμενες βλάβες που προκαλούνται από τις συσκευές μας, εφόσον οφείλονται σε μία ακατάλληλη επισκευή ή σε μια αντικατάσταση τμημάτων για την οποία δεν έχουν χρησιμοποιηθεί τα πρωτότυπα ανταλλακτικά της GARDENA ή τα από μας εγκεκριμένα ανταλλακτικά και σε περίπτωση που δεν εκτελείται η επισκευή από το Τμήμα Εξυπηρέτησης Πελατών της GARDENA ή από έναν εξουσιοδοτημένο εξειδικευμένο τεχνίτη. Το ίδιο ισχύει για εξαρτήματα και συμπληρωματικά τμήματα.

SLO Jamstvo za izdelek

Pismo poudarjamo, da po zakonu jamstva za izdelek nismo odgovorni za škodo, ki bi nastala zaradi uporabe našega izdelka, prav tako tudi ne za škodo ki bi nastala zaradi nepravilnega popravila izdelka ali pri napačni zamenjavi delov, ki niso originalni deli GARDENA ali pri uporabi z naše strani potrjenih delov, ki pa niso bili vgrajeni v servisu GARDENA ali v naši pooblaščenih servisni službi. Enako velja tudi za nadomestne dele in opremo.

HR Odgovornost za proizvod

Izričito napominjemo da u skladu sa Zakonom o odgovornosti za proizvode nismo odgovorni za štete uzrokovane našim uređajima ako su one izazvane nestručnim popravkom ili u slučaju zamjene dijelova nisu korišteni originalni GARDENA dijelovi ili dijelovi koje smo odobrili i popravak nije izvršio GARDENA servis ili ovlašteni stručnjak. Isto vrijedi i za dodatne dijelove i pribor.

RO Responsabilitatea legala a produsului

Menționăm în mod expres ca, în concordanță cu responsabilitatea legală a produsului, nu suntem răspunzători de nici un accident provocat de produsele noastre dacă se datorează reparării necorespunzătoare sau dacă piesele de schimb nu sunt originale GARDENA sau aprobate de GARDENA, sau dacă reparațiile nu au fost efectuate de un Centru de Service GARDENA sau un specialist autorizat. Aceleași prevederi se aplică și pieselor de schimb și accesoriilor.

BG Отговорност за качество

Изрично подчертаваме, че съгласно закона за отговорност за качество, ние не носим отговорност за вредите причинени от нашите уреди, ако същите са причинени от неправилен ремонт или при подмяната на части не са използвани оригинални части на GARDENA или части одобрени от нас и ремонта не е извършен от сервиз на GARDENA или оторизиран специалист. Същото важи за допълнителните части и принадлежности.

EST Tootevastutus

Juhime teie tähelepanu sellele, et tootevastutusseaduse kohaselt ei vastuta me meie seadmete poolt põhjustatud kahjude eest, kui need on tekkinud asjatundmatu paranduse tagajärjel või kui detaili vahetamisel ei kasutatud GARDENA originaalvaruosi ega meie poolt kasutada lubatud varuosia ja kui parandustöid ei ole teinud GARDENA klienditeenindusspetsialistid ega meie volitatud spetsialistid. Sama kehtib lisadetailide ja tarvikute kohta.

LT Atsakomybė už produkciją

Nurodome, kad remdamiesi Atsakomybės už produkciją įstatymu, neatsakome už nuostolius, sukeltus mūsų prietaisy, jei jie atsirado dėl netinkamo remonto, arba, jei keičiant dalis, buvo naudojamasi neoriginalios GARDENA dalys arba dalys, kurių mes neleidome naudoti, o remontą atliko ne GARDENA servisas arba neįgaliotasis specialistas. Tas pats galioja papildomoms dalims ir priedams.

LV Produkta atbildība

Mēs skaidri norādām uz to, ka saskaņā ar Produktu atbildības likumu, mēs neatbildam par mūsu iekārtu radītiem zaudējumiem, ciktāl tos ir izraisījis neatbilstošs remonts vai daļu nomaiņa ar neoriģinālām GARDENA daļām vai ne ar mūsu norādītajām detaļām un remontu nav veicis GARDENA serviss vai pilnvarots speciālists. Tas pats attiecas uz papildinošajām daļām un piederumiem.

<p>D EG-Konformitätserklärung Der Unterzeichnete Husqvarna AB, 561 82 Huskvarna, Sweden bestätigt, dass die nachfolgend bezeichneten Geräte in der von uns in Verkehr gebrachten Ausführung die Anforderungen der harmonisierten EU-Richtlinien, EU-Sicherheitsstandards und produktspezifischen Standards erfüllen. Bei einer nicht mit uns abgestimmten Änderung der Geräte verliert diese Erklärung ihre Gültigkeit.</p>	<p>H EU-Megfelelőeségi nyilatkozat Alulírott, a Husqvarna AB, 561 82 Huskvarna, Sweden igazolja azt, hogy az alábbiakban megnevezett készülékek, az általunk forgalomba hozott kivitelben teljesítik a harmonizációs EU-irányelvek, az EU biztonsági szabványok és a termékre jellemző szabványok követelményeit. Ha a készülékeken a mi beleegyezésünk nélkül változtatást végeznek, akkor ez a nyilatkozat érvényét veszti.</p>
<p>GB EU Declaration of Conformity The undersigned Husqvarna AB, 561 82 Huskvarna, Sweden hereby certifies that, when leaving our factory, the units indicated below are in accordance with the harmonised EU guidelines, EU standards of safety and product specific standards. This certificate becomes void if the units are modified without our approval.</p>	<p>CZ Prohlášení o shodě EU Podepsaný Husqvarna AB, 561 82 Huskvarna, Sweden potvrzuje, že dále uvedené přístroje v námi do provozu uvedeném provedení splňují požadavky harmonizovaných směrnic EU, bezpečnostních norem EU a norem specifických pro výrobek. Při námi neschválené změně přístrojů ztrácí toto prohlášení platnost.</p>
<p>F Certificat de conformité aux directives européennes Le constructeur, soussigné : Husqvarna AB, 561 82 Huskvarna, Sweden déclare qu'à la sortie de ses usines le matériel neuf désigné ci-dessous étai conforme aux prescriptions des directives européennes énoncées ci-après et conforme aux règles de sécurité et autres règles qui lui sont applicables dans le cadre de l'Union européenne. Toute modification portée sur ce produit sans l'accord express de GARDENA suppose la validité de ce certificat.</p>	<p>SK EU-Vyhlasenie o zhode Nižšie uvedená firma Husqvarna AB, 561 82 Huskvarna, Sweden vyhlasuje, že uvedené zariadenia, ktoré uviedla na trh v tomto vyhotovení, spĺňajú požiadavky harmonizovaných smerníc EU, bezpečnostných noriem EU a noriem špecifických pre výrobok. Pri zmene zariadenia, ktorá nebola odsúhlasená výrobcom stráca toto vyhlásenie platnosť.</p>
<p>NL EU-overeenstemmingsverklaring Ondergetekende Husqvarna AB, 561 82 Huskvarna, Sweden bevestigt, dat de volgende genoemde apparaten in de door ons in de handel gebrachte uitvoering voldoen aan de eis van, en in overeenstemming zijn met de EU-richtlijnen, de EU-veiligheidsstandaard en de voor het product specifieke standaard. Bij een niet met ons afgestemde verandering aan de apparaten verliest deze verklaring haar geldigheid.</p>	<p>GR Δήλωση Συμμόρφωσης προς τις Οδηγίες της ΕΕ Η υπογράφουσα Husqvarna AB, 561 82 Huskvarna, Sweden δηλώνει, ότι τα εξής αναφερόμενα εκδοόμενα από την εταιρία μας προϊόντα ανταποκρίνονται σε όλες τις εναρμονισμένες προδιαγραφές της ΕΕ, στα πρότυπα ασφαλείας της ΕΕ και στα ειδικά για το προϊόν πρότυπα. Σε μία μη συμφωνημένη με την εταιρία μας τροποποίηση των συσκευών αυτή η δήλωση χάνει την ισχύ της.</p>
<p>S EU Tillverkarintyg Undertecknad firma Husqvarna AB, 561 82 Huskvarna, Sweden intygar härmed att nedan nämnda produkter överensstämmer med EU:s direktiv, EU:s säkerhetsstandard och produktspecifikation. Detta intyg upphör att gälla om produkten ändras utan vårt tillstånd.</p>	<p>SLO EU-izjava o skladnosti Podpisani proizvajalca «Husqvarna AB, 561 82 Huskvarna, Sweden» s podpisom potrjuje, da sledeće opisana naprava, ki smo jo poslali na tržišče izpolnjuje zahteve harmoniziranih standardov ES-smernic, ES-varnostnih standardov in izdelku specifičnih standardov. V primeru spremembe na navpični brez našega pisnega dovoljenja ta izjava izgubi svoj pomen in veljavnost.</p>
<p>DK EU Overensstemmelse certifikat Undertegnede Husqvarna AB, 561 82 Huskvarna, Sweden bekræfter hermed, at enheder listede herunder, ved afsendelse fra fabrikken, er i overensstemmelse med harmoniserede EU retningslinjer, EU sikkerheds standarder og produkt specifikations standarder. Dette certifikat træder ud af kraft hvis enhederne er ændret uden vor godkendelse.</p>	<p>HR Izjava o skladnosti EU-a Dolje potpisana tvrtka Husqvarna AB, 561 82 Huskvarna, Sweden ovime potvrđuje da dolje navedeni uređaji u izvedbi plaširanoj na tržište ispunjavaju zahtjeve harmoniziranih EU smjernica, EU sigurnosnih normi i normi za određene proizvode. Ova izjava postaje ništavna u slučaju izmjene uređaja koje nismo odobrili.</p>
<p>FI EU-yhdenmukaisuusvakuutus Allekirjoittanut Husqvarna AB, 561 82 Huskvarna, Sweden vakuuttaa, että alla mainittu laiteet täyttävät tehtaaltamme lähtiesään yhdenmukaisistettujen EU-direktiivien, EU-turvallisuusstandardien ja tuotekohtaisten standardien vaatimukset. Laitteisiin tehyd muutokset, joista ei ole sovittu kanssamme, joutavat tämän vakuutuksen raukaamiseen.</p>	<p>RO UE-Certificat de conformitate Prin prezenta Husqvarna AB, 561 82 Huskvarna, Sweden, certifica faptul ca, in momentul in care produsele mentionate mai jos ies din fabrica sunt in concordanta cu directivele UE, standardele de siguranta UE si standardele specifice ale produsului UE. Acest certificat devine nul in cazul modificării aparatului fără aprobarea noastră.</p>
<p>I Dichiarazione di conformità alle norme UE La sottoscritta Husqvarna AB, 561 82 Huskvarna, Sweden certifica che il prodotto qui di seguito indicato, nei modelli da noi commercializzati, è conforme alle direttive armonizzate UE nonché agli standard di sicurezza e agli standard specifici di prodotto. Qualunque modifica apportata al prodotto senza nostra specifica autorizzazione invalida la presente dichiarazione.</p>	<p>BG ЕС-Декларация за съответствие Подписаната фирма Husqvarna AB, 561 82 Huskvarna, Sweden декларира, че описаните по-долу уреди, пуснати в продажба съгласно нашата спецификация, изпълняват изискванията на хармонизираните ЕС-директиви, ЕС-стандарти за безопасност и специфични производствени стандарти. При промяна на уреда, която не е съгласувана с нас, тази декларация губи своята валидност.</p>
<p>E Declaración de conformidad de la UE El que suscribe Husqvarna AB, 561 82 Huskvarna, Sweden declara que la presente mercancía, objeto de la presente declaración, cumple con todas las normas de la UE, en lo que a normas técnicas, de homologación y de seguridad se refiere. En caso de realizar cualquier modificación en la presente mercancía sin nuestra previa autorización, esta declaración pierde su validez.</p>	<p>EST Eli vastavusdeklaratsioon Allekirjutanut Husqvarna AB, 561 82 Huskvarna, Sweden kinnitab, et kirjeldatud seade vastab meie poolt riigusse viidud kujul ELi harmoniseeritud direktiividele, ELi ohutusstandarditele ja tootega seotud standarditele. Meiega kooskõlastamata muudatuse tegemise korral seadmel kaotab see deklaratsioon kehtivuse.</p>
<p>P Certificado de conformidad da UE Os abaixo mencionados Husqvarna AB, 561 82 Huskvarna, Sweden, por este meio certificam que ao sair da fábrica os aparelhos abaixo mencionados estão de acordo com as direttrizes harmonizadas da UE, padrões de segurança e de produtos específicos. Este certificado ficará nulo se as unidades forem modificadas sem a nossa aprovação.</p>	<p>LT ES Atitikties deklaracija Pasirašanti mūsų Husqvarna AB, 561 82 Huskvarna, Sweden patvirtina, kad žemiau nurodyti prietaisai ir jų modeliai, kurie buvo pagaminti mūsų gamyklose atitinka ES direktyvas, ES saugumo standartus ir specifinius gaminių standartus. Atlikus bet kokį prietaiso pakeitimą, kuris nėra suderintas su mumis, ši deklaracija praranda galiojimą.</p>
<p>PL Deklaracja zgodności Unii Europejskiej Husqvarna AB, 561 82 Huskvarna, Sweden potwierdza, że poniżej określone urządzenia w wersji oferowanej przez nas do sprzedaży spełniają wymagania zharmonizowanych dyrektyw Unii Europejskiej, standardu bezpieczeństwa Unii Europejskiej i standardu specyficznego dla tego typu produktów. W przypadku zmiany urządzenia, która nie została z nami uzgodniona, niniejsza deklaracja traci moc obowiązującą.</p>	<p>LV ES-atbilstības deklarācija Parakstīstusies Husqvarna AB, 561 82 Huskvarna, Sweden, Vācija apstiprina, ka sekojoši apzīmētās iekārtas, kurās mēs izplatām, savā izpildījumā atbilst harmonizētajām ES direktīvām, ES drošības standartiem un produkta specifiskajiem standartiem. Ar mūsu neapstiprinātām izmaiņām iekārtā šī deklarācija zaudē savu derīgumu.</p>

Deutschland / Germany

GARDENA
Manufacturing GmbH
Central Service
Hans-Lorenser-Straße 40
D-89079 Ulm
Produktfragen:
(+49) 731 490-123
Reparaturen:
(+49) 731 490-290
service@gardena.com

Albania
COBALT Sh.p.k.
Rr. Siri Kodra
1000 Tirana

Argentina
Husqvarna Argentina S.A.
Av.del Libertador 5954 –
Fiso 11 – Torre B
(C1428ARF) Buenos Aires
Phone: (+54) 11 5194 5000
info.gardena@
ar.husqvarna.com

Armenia
Garden Land Ltd.
61 Tigran Mets
0005 Yerevan

Australia
Husqvarna Australia Pty. Ltd.
Locked Bag 5
Central Coast BC
NSW 2252
Phone: (+61) (0) 2 4352 7400
customer.service@
husqvarna.com.au

Austria / Österreich
Husqvarna Austria GmbH
Industriezeile 36
4010 Linz
Tel.: (+43) 732 77 01 01-485
service.gardena@
husqvarnagroup.com

Azerbaijan
Firm Progress
a. Aliyev Str. 26A
1052 Bakı

Belgium
GARDENA Belgium NV/SA
Sterrebeekstraat 163
1930 Zaventem
Phone: (+32) 2 720 92 12
Mail: info@gardena.be

Bosnia / Herzegovina
SILK TRADE d.o.o.
Industrijska zona Bukva bb
74260 Tešanj

Brazil
Husqvarna do Brasil Ltda
Av. Francisco Matarazzo,
1400 – 19º andar
São Paulo – SP
CEP: 05001-903
Tel: 0800-112252
marketing.br.husqvarna@
husqvarna.com.br

Bulgaria
Хускварна България ЕООД
Бул. „Андрей Ляпчев“ № 72
1799 София
Тел.: (+359) 02/9753076
www.husqvarna.bg

Canada / USA
GARDENA Canada Ltd.
100 Summerlee Road
Brampton, Ontario L6T 4X3
Phone: (+1) 905 792 9330
info@gardenacanada.com

Chile
Maquinarias Agroforestales
Ltda. (Maga Ltda.)
Santiago, Chile
Avda. Chesteron
8355 comuna Las Condes
Phone: (+56) 2 202 4417
Dalton@мага.cl
Zipcode: 7560330
Temuco, Chile
Avda. Valparaíso # 01466
Phone: (+56) 455 222 126
Zipcode: 4780441

China

Husqvarna (China) Machinery
Manufacturing Co., Ltd.
No. 1355, Jia Xin Rd.,
Ma Lu Zhen, Jia Ding Dist.,
Shanghai
201801
Phone: (+86) 21 59159629
Domestic Sales
www.gardena.com.cn

Colombia
Husqvarna Colombia S.A.
Calle 18 No. 68 D-31, zona
Industrial de Montevideo
Bogotá, Cundinamarca
Tel. 571 2922700 ext. 105
jairo.salazar@
husqvarna.com.co

Costa Rica
Compania Exim
Euroberoamericana S.A.
Los Colegios, Moravia,
200 metros al Sur del Colegio
Saint Francis – San José
Phone: (+506) 297 68 83
exim_euro@racsa.co.cr

Croatia
SILK ADRIA d.o.o.
Josipa Lončara 3
10090 Zagreb
Phone: (+385) 1 3794 580
silk.adria@zg.t-com.hr

Cyprus
Med Marketing
17 Digeni Akritia Ave
P.O. Box 27017
1641 Nicosia

Czech Republic
Husqvarna Česko s.r.o.
Türkova 2319/5b
149 00 Praha 4 – Chodov
Bezpłatná infolinka:
800 100 425
servis@cz.husqvarna.com

Denmark
GARDENA / Husqvarna
Consumer Outdoor Products
Salgsafdelning Danmark
Box 9003
S-200 39 Malmö
info@gardena.dk

Dominican Republic
BOSQUESA, S.R.L
Carretera Santiago Licey
Km 5 1/2
Esquina Copal II,
Santiago
Dominican Republic
Phone: (+809) 736-0333
joserbosquesa@claro.net.do

Ecuador
Husqvarna Ecuador S.A.
Agrupos E1-181 y 10 de
Agosto Quito, Pichincha
Tel. (+593) 22800739
francisco.jacom@
husqvarna.com.ec

Estonia
Husqvarna Eesti OÜ
Consumer Outdoor Products
Kesk tee 10, Aaviku küla
Rae vald
Harju maakond
75305 Estonia
kontakt.etj@husqvarna.ee

France
Husqvarna France
9/11 Allée des pierres mayettes
92635 Gennevilliers Cedex
France
http://www.gardena.com/fr
N° AZUR: 0 810 00 78 23
(Prix d'un appel local)

Georgia

ALD Group
Bellashvili 8
1159 Tbilisi

Great Britain
Husqvarna UK Ltd
Preston Road
Aycliffe Industrial Park
Newton Aycliffe
Consumer Durham
DL5 6UP
info.gardena@
husqvarna.co.uk

Greece
Π. ΠΑΠΑΔΟΠΟΥΛΟΣ ΑΕΒΕ
Λεωφ. Αθηνών 92
Αθήνα
Τ.Κ. 104 42
Ελλάδα
Τηλ. (+30) 210 5193 100
info@papakodopoulos.com.gr

Hungary
Husqvarna Magyarorszáig Kft.
Ezred u. 1-3
1044 Budapest
Telefon: (+36) 1 251-4161
vevozolgalat.husqvarna@
husqvarna.hu

Iceland
Ó. Johnson & Kaaber
Túnguhsali 1
110 Reykjavík
ojo@oik.is

Ireland
Husqvarna UK Ltd
Preston Road
Aycliffe Industrial Park
Newton Aycliffe
County Durham
DL5 6UP
info.gardena@
husqvarna.co.uk

Italy
Husqvarna Italia S.p.A.
Via Como 72
23868 VALMADRERA (LC)
Phone: (+39) 0341.203.111
info@gardenaitalia.it

Japan
KAKUICHI Co. Ltd.
Sumitomo Realty &
Development Kojimachi
BLDG., 8F
5-1 Nibanncyo
Chiyoda-ku
Tokyo 102-0084
Phone: (+81) 33 264 4721
m_ishihara@kaku-ichi.co.jp

Kazakhstan
LAMED Ltd.
155/1, Tazhibayevy Str.
050060 Almaty
IP Schmidt
Abayavenue 3B
110 005 Kostanay

Korea
Kyung Jin Trading Co., Ltd.
107-4, SunDuk Bld.,
Yangjae-dong,
Secho-gu,
Seoul, (zipcode: 137-891)
Phone: (+82) (0)2 574-6300

Kyrgyzstan
Alyz Maki
av. Molodaya Guardir J 3
720014
Bishkek

Latvia
Husqvarna Latvija
Consumer Outdoor Products
Bakūži iela 6
LV-1024 Rīga
info@husqvarna.lv

Lithuania
UAB Husqvarna Lietuva
Consumer Outdoor Products
Ateities pl. 77C
LT-52104 Kaunas
centras@husqvarna.lt

Luxembourg

Magasins Jules Neuberg
39, rue Jacques Stas
Luxembourg-Gasperich 2549
Case Postale No. 12
Luxeburg 2010
Phone: (+352) 40 14 01
ari@neuberg.lu

Mexico
AFOSA
Av. Lopez Mateos Sur # 5019
Col. La Calma 45070
Zapopan, Jalisco
Mexico
Phone: (+52) 33 3818-3434
icornejo@afosa.com.mx

Moldova
Convel S.R.L.
290A Muncesti Str.
2002 Chisinau

Netherlands
GARDENA Nederland B.V.
Postbus 50176
1305 AD ALMERE
Phone: (+31) 36 521 00 00
info@gardena.nl

Neth. Antilles
Jonka Enterprises N.V.
Sta. Rosa Weg 196
P.O. Box 8200
Curaçao
Phone: (+599) 9 767 66 55
pjm@jonka.com

New Zealand
Husqvarna New Zealand Ltd.
PO Box 76-437
Manukau City 2241
Phone: (+64) (0) 9 9202410
support.nz@husqvarna.co.nz

Norway
GARDENA
Husqvarna Consumer
Outdoor Products
Salgskontor Norge
Kleiverveien 6
1540 Vestby
info@gardena.no

Peru
Husqvarna Perú S.A.
Jr. Ramón Cárcamo 710
Lima 1
Tel: (+51) 1 3320400 ext. 416
juan_remujo@
husqvarna.com

Poland
Husqvarna
Poland Spółka z o.o.
ul. Wysockiego 15 b
03-371 Warszawa
Phone: (+48) 22 330 96 00
gardena@husqvarna.pl

Portugal
Husqvarna Portugal, SA
Lagoa – Albarraque
2635 – 595 Rio de Mouro
Tel.: (+351) 21 922 85 30
Fax.: (+351) 21 922 85 36
info@gardena.pt

Romania
Madex International Srl
Soseaua Odaii 117-123,
RO 013603 București, S 1
Phone: (+40) 21 352.76.03
madex@ines.ro

Russia / Россия
ООО „Хускварна“
141400, Московская обл.,
г. Химки,
улица Ленинградская,
владение 39, стр.6
Бизнес Центр
„Химки бизнес Парк“,
помещение 0802.04
http://www.gardena.ru

Serbia
Domet d.o.o.
Autoput za Novi Sad bb
11273 Belgrade
Phone: (+381) 11 848 88 12
miroslav.jejina@domet.rs

Singapore

Hy-Ray PRIVATE LIMITED
40 Jalan Pemimpin
#02-08 Tat Ann Building
Singapore 577185
Phone: (+65) 6253 2277
shiyang@hyray.com.sg

Slovak Republic
Husqvarna Česko s.r.o.
Türkova 2319/5b
149 00 Praha 4 – Chodov
Bezpłatná infolinka:
800 154 044
servis@sk.husqvarna.com

Slovenia
Husqvarna Austria GmbH
Industriezeile 36
4010 Linz
Tel.: (+43) 732 77 01 01-485
service.gardena@
husqvarnagroup.com

South Africa
Husqvarna
South Africa (Pty) Ltd
Postnet Suite 250
Private Bag X6,
Cascades, 3202
South Africa
Phone: (+27) 33 846 9700
info@gardena.co.za

Spain
Husqvarna España S.A.
Calle de Rivas nº 10
28052 Madrid
Phone: (+34) 91 708 05 00
atencioncliente@gardena.es

Suriname
Agrofix n.v.
Verlengde Hogestraat # 22
Phone: (+597) 472426
agrofix@sr.net
Pobox : 2006
Paramaribo
Suriname – South America

Sweden
Husqvarna AB
S-561 82 Huskvarna
info@gardena.se

Switzerland / Schweiz
Husqvarna Schweiz AG
Consumer Products
Industriestrasse 10
5506 Mägenwil
Phone: (+41) (0) 62 887 37 90
info@gardena.ch

Turkey
GARDENA Deste Diş Ticaret
Mümesillik A.Ş.
Sanayi Cad. Adil Sokak
No: 1/B Kartal
34873 İstanbul
Phone: (+90) 216 38.93.939
info@gardena-dost.com.tr

Ukraine / Україна
ТОВ „Хусварна Україна“
вул. Васильківська, 34,
офіс 204-р
03022, Київ
Тел. (+38) 044 498 39 02
info@gardena.ua

Uruguay
FELI SA
Entre Rios 1083 CP 11800
Montevideo – Uruguay
Tel: (+598) 22 03 18 44
info@felisa.com.uy

Venezuela
Corporación Casa y Jardín C.A.
Av. Caroni, Edif. Trazzmen, PB.
Colinas de Bello Monte.
1050 Caracas.
Tlf: (+58) 212 992 33 22
info@casayjardin.net.ve

8881-20.960.04/0316
© GARDENA
Manufacturing GmbH
D-89070 Ulm
http://www.gardena.com